

NUMBER <b>BUS-12-070</b>	TYPE <b>PRODUCT SPECIFICATION</b>		
TITLE Low Profile Jumper – Tin/Lead Plated		PAGE 1 of 15	REVISION F
		AUTHORIZED BY A. LUGO	DATE 28 Oct 08
CLASSIFICATION <b>UNRESTRICTED</b>			

## 1.0 GENERAL

Scope - This specification covers tin-lead plated low profile jumper connectors designed for low power interconnection of two adjacent 0.025 inch square pins, free standing or in headers, on 0.100 inch centers. This specification is composed of the following sections. This product meets the requirements of the European Union Directive of Restrictions for Hazardous Substances (Directive 2002/95/EC). The specification is composed of the following sections.

<u>Paragraph</u>	<u>Title</u>	<u>Page</u>
1.0	GENERAL	1
2.0	APPLICABLE DOCUMENTS	1
3.0	REQUIREMENTS	2
3.1	Qualification	2
3.2	Material	2
3.3	Finish	2
3.4	Design and Construction	3
3.5	Electrical Characteristics	3
3.6	Mechanical Characteristics	6
3.7	Environmental Conditions	7
4.0	QUALITY ASSURANCE PROVISIONS	11
4.1	Equipment Calibration	11
4.2	Inspection Conditions	12
4.3	Qualification Inspections	12
4.4	Requalification Testing	13
5.0	NOTES AND DEFINITIONS	16

## 2.0 APPLICABLE DOCUMENTS

The following documents, of the issue in effect on the date of the latest revision of this specification, shall form a part of this specification to the extent specified herein.

### Military Specifications

MIL-M-24519	Molding Plastics, Polyester, Thermoplastics
MIL-C-45662	Calibration System Requirements
MIL-P-55110	Printed Wiring Boards
MIL-T-10727	Tin Plating, Electrodeposited or Hot-Dipped, for Ferrous and Non-Ferrous Metals
MIL-STD-202	Test Methods for Electronic and Electrical Component Parts
MIL-STD-275	Printed Wiring for Electronic Equipment
MIL-STD-1344	Test Methods for Electrical Connectors

### Federal Specifications

QQ-S-571	Solder Lead Alloy, Tin Lead Alloy, and Tin Alloy: Flux Cored Ribbon and Wire, and Solid Form
QQ-N-290	Nickel Plating (Electrodeposited)
QQ-B-750	Phosphor Bronze

NUMBER <b>BUS-12-070</b>	TYPE <b>PRODUCT SPECIFICATION</b>		
TITLE Low Profile Jumper – Tin/Lead Plated		PAGE 2 of 15	REVISION F
		AUTHORIZED BY A. LUGO	DATE 28 Oct 08
CLASSIFICATION <b>UNRESTRICTED</b>			

Industry Specifications/Standards

ASTM B-103      Phosphor Bronze Plate, Sheet, Strip and Rolled Bar, Spec. for DOD ADOPTED

UL-94            Tests for Flammability of Plastic Materials

**3.0 REQUIREMENTS**

3.1 Qualification

Connectors furnished under this specification shall be products capable of meeting the qualification test requirements specified herein.

3.2 Material

The material for each part shall be as specified herein, or equivalent. Substitute material shall meet the performance requirements of this specification.

3.2.1 Terminal. The body shall be 1/2 hard phosphor bronze strip C51000 in accordance with QQ-B-750 and CA-510 specification.

3.2.2 Insulator Housing. The housing material shall be unfilled Polyester in accordance with BUS-16-028. The material shall be rated flame retardant 94 V-O in accordance with UL-94.

or

3.2.3 Insulator Housing. The housing material shall be 17-20% glass filled Polyester in accordance with BUS-16-025. The material shall be rated flame retardant 94 V-0 in accordance with UL-94.

3.3 Finish

3.3.1 The terminal shall be plated with 100 to 300 microinches of tin-lead per MIL-T-10727, Type 1 or will plated with 100 to 160 microinches of pure tin.

NUMBER <b>BUS-12-070</b>	TYPE <b>PRODUCT SPECIFICATION</b>		
TITLE Low Profile Jumper – Tin/Lead Plated		PAGE 3 of 15	REVISION F
		AUTHORIZED BY A. LUGO	DATE 28 Oct 08
CLASSIFICATION <b>UNRESTRICTED</b>			

### 3.4 Design and Construction

The connector typically shall be a two piece assembly comprising two interconnected contacts retained in a plastic housing. The female (disconnect) end of the contact shall interface with 0.025 inch square (or round) pins on 0.100 inch centers.

- 3.4.1 Mating. The connector shall be capable of being mated or unmated by hand without the use of special tools within the specified temperature range.
- 3.4.2 Workmanship. Connectors shall be uniform in quality and shall be free from burrs, scratches, cracks, voids, chips, blisters, pin holes, sharp edges, and other defects that will adversely affect life or serviceability.
- 3.4.3 Interchangeability. The connector shall be capable of mating with any appropriately constituted male connector of the same population without degradation in performance.

### 3.5 Electrical Characteristics

- 3.5.1 Current Rating. The maximum current rating of the connector shall be 3.0 amperes DC (2.5 amperes for multi-position assembly).
- 3.5.2 Contact Resistance. (see 5.1) The contact resistance shall not exceed the value specified in Table 1, when measured in accordance with MIL-STD-202, Method 307. The following details shall apply:
  - (a) Method of Connection - Attach current and voltage leads as shown in Figure 1.
  - (b) Test Current - 1 ampere DC

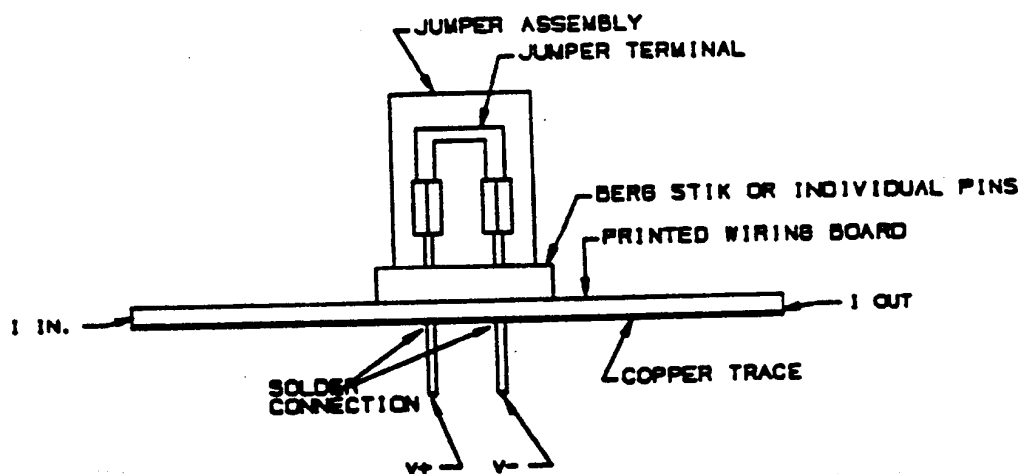

**FIGURE 1 - CONTACT RESISTANCE**

NUMBER <b>BUS-12-070</b>	TYPE <b>PRODUCT SPECIFICATION</b>		
TITLE Low Profile Jumper – Tin/Lead Plated		PAGE 4 of 15	REVISION F
		AUTHORIZED BY A. LUGO	DATE 28 Oct 08
CLASSIFICATION <b>UNRESTRICTED</b>			

**TABLE 1 - CONTACT RESISTANCE**

Maximum Resistance Initial	Milliohms After Test
11	15

- 3.5.3 Low Level Circuit Resistance. (See 5.1) The low level circuit (contact) resistance shall not exceed the value specified in Table 1, when measured in accordance with MIL-STD-1344, Method 3002. The following details shall apply:
- (a) Method of Connection - See Figure 1
  - (b) Test Current - 1 milliampere DC
  - (c) Maximum Open Circuit Voltage - 20 millivolts DC
- 3.5.4 Capacitance. (See 5.3) The capacitance between adjacent positions of the unmated connector shall not exceed 2.0 pf, when measured in accordance with MIL-STD-202, Method 305. The following details shall apply:
- (a) Points of Measurement - Between adjacent contact positions
  - (b) Test Frequency - 1 megahertz
- 3.5.5 Insulation Resistance. (See 5.3) The insulation resistance between adjacent positions of the unmated connector shall be not less than 50,000 megohms (20,000 megohms after exposure to the humidity environment specified in paragraph 3.7.2), when tested in accordance with MIL-STD-202, Method 302. The following details shall apply:
- (a) Points of Measurement - Between adjacent contact positions
  - (b) Test Potential - B (500 volts)
  - (c) Time of Application - 60 seconds
- 3.5.6 Dielectric Withstanding Voltage. (See 5.3) There shall be no evidence of insulation breakdown, arc-over, or excessive (>1 milliampere) leakage current when the unmated connector is tested in accordance with MIL-STD-202, Method 301. The following details shall apply:
- (a) Test Potential - 1500 volts RMS, 60 Hz at sea-level
  - (b) Test Duration - 60 seconds
  - (c) Points of Measurement - Between adjacent contact positions

NUMBER <b>BUS-12-070</b>	TYPE <b>PRODUCT SPECIFICATION</b>		
TITLE Low Profile Jumper – Tin/Lead Plated		PAGE 5 of 15	REVISION F
		AUTHORIZED BY A. LUGO	DATE 28 Oct 08
CLASSIFICATION <b>UNRESTRICTED</b>			

### 3.6 Mechanical Characteristics

- 3.6.1 Contact Retention. (See 5.2) The contact pair shall not be dislodged from the housing when an axial force of 3.0 pounds (1.5 pounds per contact) is applied in the direction of insertion. The force shall be applied at a crosshead speed of 1 inch per minute using fixture # MF 407.1. (See Figure 6)
- 3.6.2 Total Mating Force. The total force to mate the connector with an appropriate header having properly configured (see Figure 2) 0.025 inch square pins shall not exceed the value shown in Table II.

**TABLE II - INSERTION/WITHDRAWAL FORCE**

Individual Contact Force-Grams Insert (Max.)	Withdraw (Min.)	Total Mating Force for 2 Contacts ( Grams-Avg.)	Total Withdrawal Force for 2 Contacts ( Grams Avg.)
.026" Gage Pin	.024 Gage Pin	.025" Gold Pin	.025" Gold Pin
450*	40*	400	150

\* Multiply by number of positions for multi-position assembly.

- 3.6.3 Individual Contact Insertion Force. When measured using a maximum gage configured as shown in Figure 3, the individual contact insertion force shall not exceed the value shown in Table II.
- 3.6.4 Individual Contact Withdrawal Force. After three insertions of a maximum gage, the force required to withdraw a minimum gage, configured as shown in figure 3, shall be not less than the value shown in Table II.
- 3.6.5 Durability. After the number of mating cycles specified in Table III, the individual contact withdrawal force shall be not less than the value shown in Table II (see 3.6.4) and the contact resistance shall not exceed the value specified in Table I (see 3.5.2).

**TABLE III - DURABILITY**

Tin lead Plating Thickness	Mating Cycles
100-300u"	25

NUMBER <b>BUS-12-070</b>	TYPE <b>PRODUCT SPECIFICATION</b>		
TITLE Low Profile Jumper – Tin/Lead Plated		PAGE 6 of 15	REVISION F
		AUTHORIZED BY A. LUGO	DATE 28 Oct 08
CLASSIFICATION <b>UNRESTRICTED</b>			

### 3.7 Environmental Conditions

3.7.1 Thermal Shock. After exposure of the mated connector to alternate periods of extreme high and low temperature, there shall be no evidence of cracking or crazing of the insulator housing or other physical damage to the connector; the dielectric withstanding voltage of the unmated connector shall be not less than 2500 volts RMS (see 3.5.6). The test shall be in accordance with MIL-STD-202, Method 107. The following details and exceptions shall apply:

- (a) Test Condition - A (5, 1-hour cycles)
- (b) Temperature Range - +120<sup>0</sup>C to -55<sup>0</sup>C
- (c) Exposure time at each temperature - 30 minutes, minimum
- (d) Transfer time - 30 seconds maximum

3.7.2 Humidity. After exposure of the mated connector to a high humidity environment, the contact resistance shall not exceed the value specified in Table I (see 3.5.2). The insulation resistance of the unmated connector shall be not less than 20,000 megohms (see paragraph 3.5.5). The test shall be in accordance with MIL-STD-202, Method 106 (excluding steps 7a and 7b). The following details shall apply:

- (a) Test Duration - 10 days (240 hours)

3.7.3 High Temperature Life. After exposure of the mated connector to a high temperature operating environment, the contact resistance shall not exceed the value specified in Table I (see 3.5.2). The insulation resistance of the unmated connector shall be not less than 50,000 megohms (see 3.5.5). The test shall be in accordance with MIL-STD-202, Method 108. The following details shall apply:

- (a) Chamber Temperature - Adjusted to achieve +120<sup>0</sup>C temperature of contact under load.
- (b) Test Condition - B (250 hours)
- (c) Operating Conditions - Rated current (see 3.5.1) through both contacts; duty cycle: 45 minutes ON and 15 minutes OFF.

NUMBER <b>BUS-12-070</b>	TYPE <b>PRODUCT SPECIFICATION</b>		
TITLE Low Profile Jumper – Tin/Lead Plated		PAGE 7 of 15	REVISION F
		AUTHORIZED BY A.LUGO	DATE 28 Oct 08
CLASSIFICATION <b>UNRESTRICTED</b>			

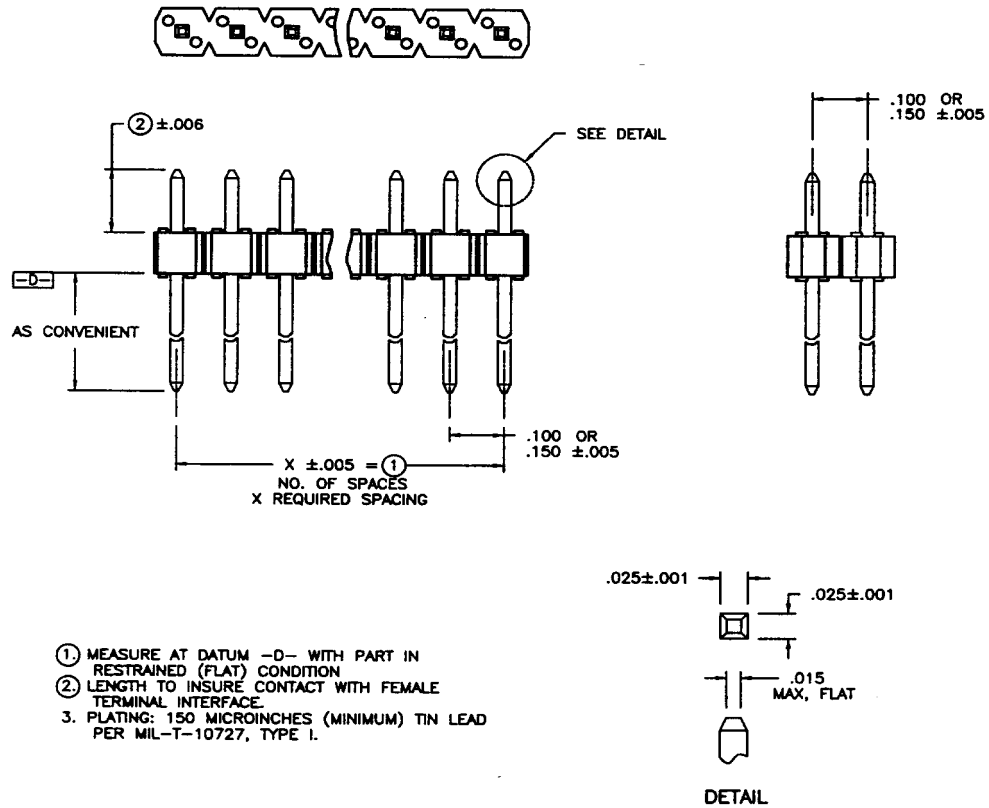

**FIGURE 2 - MATING HEADER**

NUMBER <b>BUS-12-070</b>	TYPE <b>PRODUCT SPECIFICATION</b>		
TITLE Low Profile Jumper – Tin/Lead Plated		PAGE 8 of 15	REVISION F
		AUTHORIZED BY A.LUGO	DATE 28 Oct 08
		CLASSIFICATION <b>UNRESTRICTED</b>	

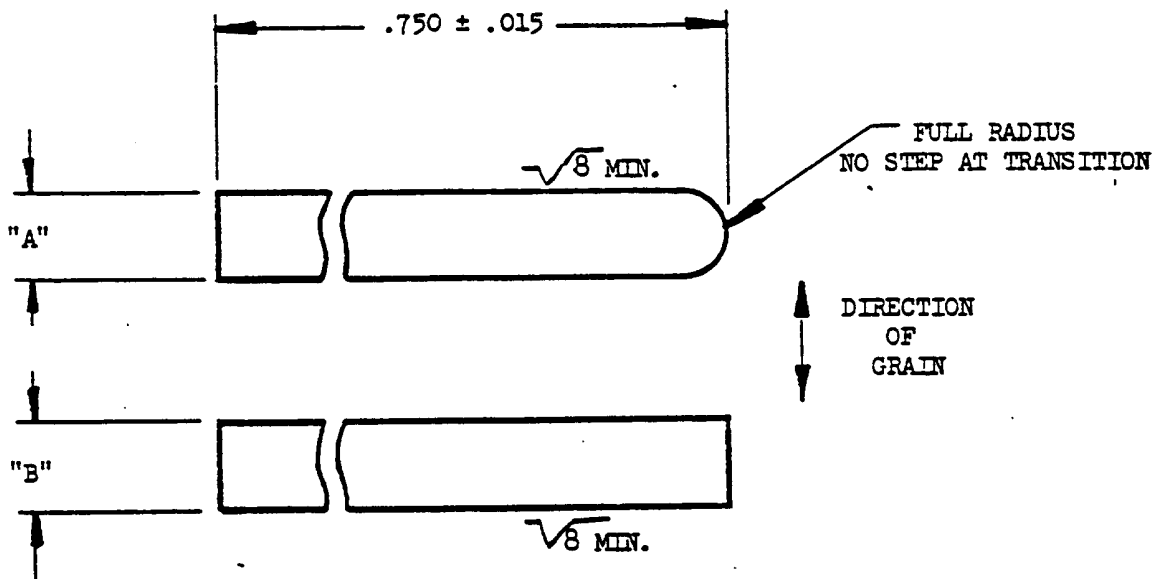

GAGE	DIMENSIONS - INCH			
	A	TOL.	B	TOL.
MIN.	.0240	+ .0000 - .0002	.025	± .001
MAX.	.0260	+ .0002 - .0000	.025	± .001

Material: Shim stock; grind to width and break edges; do not polish working surface.

Clean gage as follows before each use:

- A. Scour surface with mildly abrasive material (rubber eraser, e.g.)
- B. Wash surface with Freon and dry with clean cotton. DO NOT TOUCH SURFACE WITH FINGERS.

**FIGURE 3 - INSERTION/WITHDRAWAL FORCE GAGE**



NUMBER <b>BUS-12-070</b>	TYPE <b>PRODUCT SPECIFICATION</b>		
TITLE Low Profile Jumper – Tin/Lead Plated		PAGE 9 of 15	REVISION F
		AUTHORIZED BY A.LUGO	DATE 28 Oct 08
CLASSIFICATION <b>UNRESTRICTED</b>			

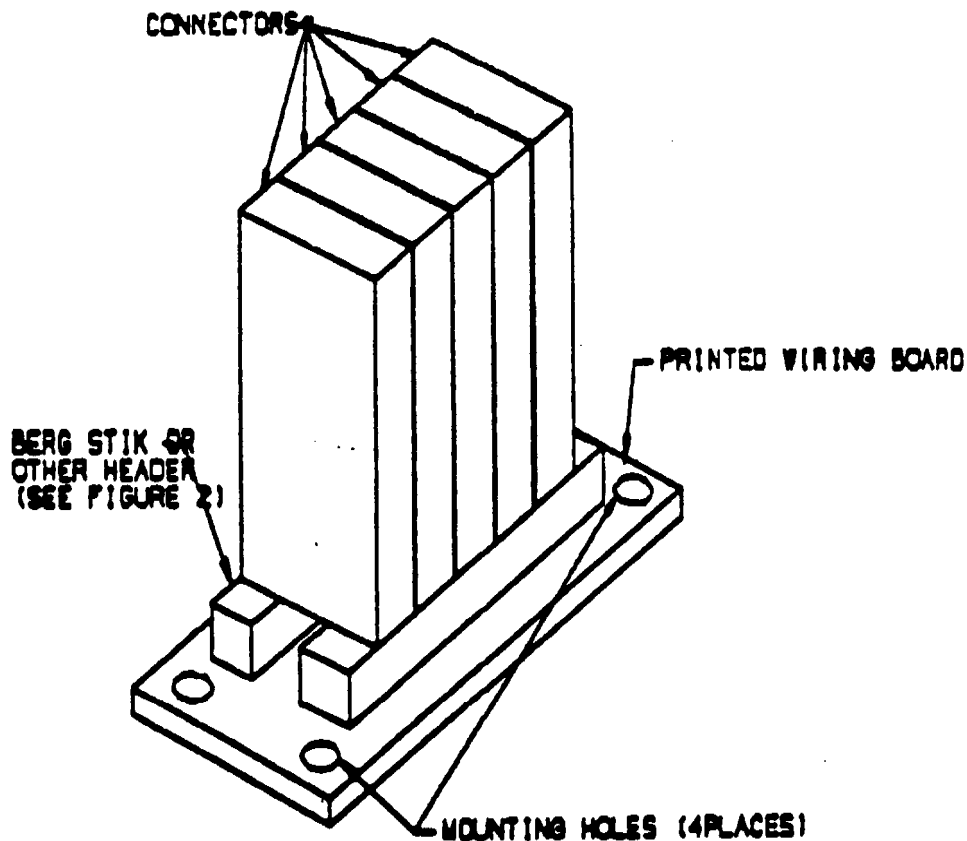

CONNECTORS STACKED ON .100 OR  
.150 CENTERS, AS APPROPRIATE.

**FIGURE 4 - MOUNTING FOR STOCK/VIBRATION**

NUMBER <b>BUS-12-070</b>	TYPE <b>PRODUCT SPECIFICATION</b>		
TITLE Low Profile Jumper – Tin/Lead Plated		PAGE 10 of 15	REVISION F
		AUTHORIZED BY A. LUGO	DATE 28 Oct 08
CLASSIFICATION <b>UNRESTRICTED</b>			

- 3.7.4 Shock. There shall be no evidence of physical or mechanical damage when the mated connector is subjected to transient accelerations. During and after each shock, the contacts shall evidence no discontinuity greater than 1 microsecond. The test shall be in accordance with MIL-STD-202, Method 213. The following details shall apply:
- (a) Test Condition - 1 (100G, 6 ms sawtooth).
  - (b) Number of Shocks - 3 shocks in each direction along three orthogonal axes (18 total).
  - (c) Mounting - See Figure 4
  - (d) Restraining Method - None
- 3.7.5 Vibration. There shall be no evidence of physical or mechanical damage when the mated connector is subjected to prolonged mechanical vibration; and the individual contact withdrawal force shall be not less than the value specified in Table II (see 3.6.4). During the vibration along each axis, the contacts shall evidence no discontinuity greater than 1 microsecond. At the completion of the test, the contact resistance shall not exceed the value specified in Table I (see 3.5.2). The test shall be in accordance with MIL-STD-202, Method 204. The following details shall apply:
- (a) Test Condition - B (□15G, 10 to 2000 Hz)
  - (b) Test Duration - 4 hours along each of three orthogonal axes (12 hours total)
  - (c) Mounting - see Figure 4
  - (d) Restraining Method - None
- 3.7.6 Hydrogen Sulfide (H<sub>2</sub>S) Atmosphere. After exposure of the mated connector to moist contaminated environment, the low level circuit resistance shall not exceed the value specified in Table I (see 3.5.3). The following details shall apply:
- (a) Test Medium - 3 ppm H<sub>2</sub>S in air
  - (b) Test Temperature - +40°C
  - (c) Test Duration - 48 hours

#### 4.0 QUALITY ASSURANCE

##### 4.1 Equipment Calibration

All test equipment and facilities used in the performance of any test shall be maintained in a calibration system in accordance with MIL-C-45662.

NUMBER <b>BUS-12-070</b>	TYPE <b>PRODUCT SPECIFICATION</b>		
TITLE Low Profile Jumper – Tin/Lead Plated		PAGE 11 of 15	REVISION F
		AUTHORIZED BY A.LUGO	DATE 28 Oct 08
CLASSIFICATION <b>UNRESTRICTED</b>			

#### 4.2 Inspection Conditions

Unless otherwise specified herein, all inspections shall be performed under the following ambient conditions:

- (a) Temperature -  $25^{\circ}\text{C} \pm 5^{\circ}\text{C}$
- (b) Relative Humidity - 30% to 80%
- (c) Barometric Pressure - Local ambient

#### 4.3 Qualification Inspection

Qualification inspection shall be performed on sample units produced with equipment normally used in production.

4.3.1 Sample. Qualification Inspection shall be performed on five (5) groups of connectors; each group shall comprise five (5) connectors of each type for which qualification under this specification is desired. For multi-position connectors, a sixth sample (one connector) shall be required for Group 3 tests.

##### 4.3.2 Preparation of Samples

4.3.2.1 Printed Wiring Test Boards - Five (5) test boards conforming to the applicable requirements of MIL-P-55110 and MIL-STD-275 shall be prepared as shown in Figure 5.

4.3.2.2 Mating Headers - Five (5) mating headers of the appropriate population and configuration and conforming to the requirements of Figure 2 shall be prepared.

4.3.2.3 Header Mounting - The headers shall be installed on, and hand soldered to, the test boards; an appropriately active flux shall be used to ensure that the connection does not contribute any degradation.

4.3.2.4 Sample Configuration - When mated with the headers, the connectors shall form a series connected circuit.

4.3.3 Test Sequence. The connectors shall be subjected to the inspections specified in Table IV, in the order shown.

NUMBER <b>BUS-12-070</b>	TYPE <b>PRODUCT SPECIFICATION</b>		
TITLE Low Profile Jumper – Tin/Lead Plated		PAGE 12 of 15	REVISION F
		AUTHORIZED BY A.LUGO	DATE 28 Oct 08
CLASSIFICATION <b>UNRESTRICTED</b>			

#### 4.4 Requalification Testing

If either of the following conditions occurs, the product responsible engineer shall initiate requalification testing.

4.4.1 A significant design change is made to an existing product previously qualified under this specification. A significant design change shall be defined to include, but not be limited to, changes in contact material composition, contact material thickness, contact force, contact surface geometry, underlying material composition, underlying material thickness, insulator design, contact base material, or contact lubrication requirements.

4.4.2 A product failure occurs during production or end use requiring corrective action to be taken relative to the product design or manufacturing process.

Requalification testing shall consist of all or applicable parts of the Qualification Test Matrix as determined by development/product, quality, test, and reliability engineering.

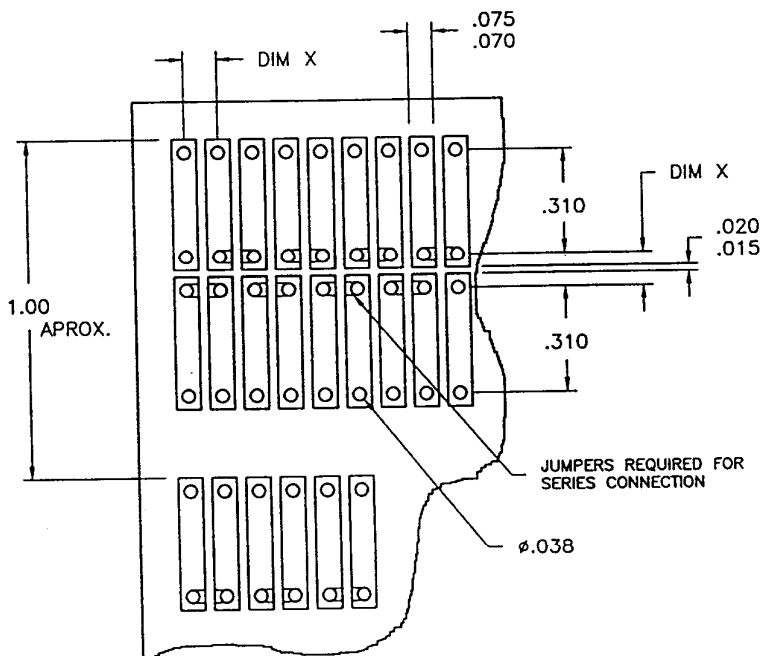

**FIGURE 5**

- NOTES:
1. "X" : .100 ±.002 OR .150 ±.002, AS REQUIRED.
  2. MATERIAL : 20% SINGLE-SIDE 1/16 IN. G-10 BOARD.
  3. PLATING : IMMERSION TIN
  4. PATTERN INTERACTIVE ACROSS LENGTH AND WIDTH OF BOARD.

NUMBER <b>BUS-12-070</b>	TYPE <b>PRODUCT SPECIFICATION</b>		
TITLE Low Profile Jumper – Tin/Lead Plated		PAGE 13 of 15	REVISION F
		AUTHORIZED BY A.LUGO	DATE 28 Oct 08
		CLASSIFICATION <b>UNRESTRICTED</b>	

**TABLE IV - QUALIFICATION INSPECTION**

<u>Examination or Test</u>	<u>Paragraph</u>	<u>Sample Group</u>					
		<u>1</u>	<u>2</u>	<u>3</u>	<u>4</u>	<u>5</u>	<u>6</u>
Total Mating Force	3.6.2	-	-	-	X	X	X
Individual Contact Withdrawal Force	3.6.4	-	-	-	X	X	X
Contact Resistance	3.5.2	X	X	-	X	X	X
Capacitance	3.5.4	-	-	X	-	-	-
Insulation Resistance	3.5.5	-	-	X	-	-	-
Dielectric Withstanding Voltage	3.5.6	-	-	X	-	-	-
Contact Retention	3.6.1	X	X	-	X	X	X
Thermal Shock	3.7.1	X	X	X	-	-	-
Dielectric Withstanding Voltage	3.5.6	-	-	X	-	-	-
Humidity	3.7.2	X	X	X	-	-	-
Contact Resistance	3.5.2	X	X	-	-	-	-
Insulation Resistance	3.5.5	-	-	X	-	-	-
High Temperature Life	3.7.3	X	-	X	-	-	-
Contact Resistance	3.5.2	X	X	-	-	-	-
Insulation Resistance	3.5.5	-	-	X	-	-	-
Shock	3.7.4	-	-	-	X	X	-
Vibration	3.7.5	-	-	-	X	X	-
Contact Resistance	3.5.2	-	-	-	X	X	-
Individual Contact	3.6.4	-	-	-	X	X	-
Durability	3.6.5	-	-	-	X	-	X
Contact Resistance	3.5.2	-	-	-	X	-	X
Individual Contact Withdrawal Force	3.6.4	-	-	-	X	-	X
Hydrogen Sulfide Atmosphere	3.7.6	-	-	-	X	X	X
Low level Circuit Resistance	3.5.3	-	-	-	X	X	X
Contact Retention	3.6.1	X	-	-	X	-	-

NUMBER <b>BUS-12-070</b>	TYPE <b>PRODUCT SPECIFICATION</b>		
TITLE Low Profile Jumper – Tin/Lead Plated		PAGE 14 of 15	REVISION F
		AUTHORIZED BY A.LUGO	DATE 28 Oct 08
CLASSIFICATION <b>UNRESTRICTED</b>			

## 5.0 NOTES AND DEFINITIONS

### 5.1 Contact Resistance

Differences in contact resistance between various terminal configurations represent changes in bulk resistance due to longer lengths of current path.

### 5.2 Contact Retention

Only terminals employing an integral latching mechanism (e.g. barbs, dimples, etc.) for rigid retention within the housing are subject to this requirement. Terminals which "free-float" within a housing and are retained by the closure of some form of hinged cover are not included.

### 5.3 Multi-Position Connector

Assemblies containing more than one jumper shall be subjected to the Group 3 tests; these tests do not apply to single position devices.

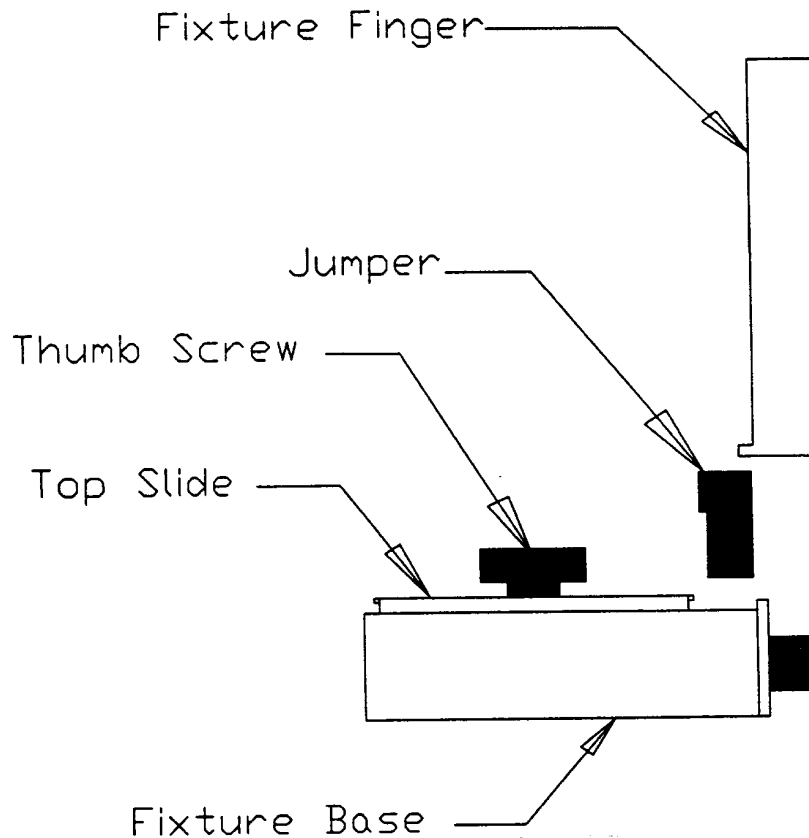

**FIXTURE # 407.1 FIGURE 6**  
**REVISION RECORD**

NUMBER <b>BUS-12-070</b>	TYPE <b>PRODUCT SPECIFICATION</b>		
TITLE Low Profile Jumper – Tin/Lead Plated		PAGE 15 of 15	REVISION F
		AUTHORIZED BY A.LUGO	DATE 28 Oct 08
CLASSIFICATION <b>UNRESTRICTED</b>			

<u>REV</u>	<u>PAGE</u>	<u>DESCRIPTION</u>	<u>EC#</u>	<u>DATE</u>
A	ALL	Change from preliminary to released	V10415	02/26/91
B	5		V12241	08/06/91
C	6	Delete max load for 10 seconds. Add use fixture # 407.1, Figure 6. Add Figure 6	V80421	12/10/98
D	ALL	Revised format to be consistent with GS-01-001, and change BERG, Dupont, etc. references to FCI.	V01904	08/01/00
E	1-2	Add lead free information	M06-0228	6/12/06
F	ALL	Change to 17-20% glass fiber polyester page 2	M08-0312	10/28/08