



NUMBER GS-12-0844	TYPE PRODUCT SPECIFICATION		
TITLE 0.5mm Pitch FPC Connector SFV__R-3/4STE_HLF		PAGE 1 of 10	REVISION A
		AUTHORIZED BY Sei Watanabe	DATE 2011-2-9
		CLASSIFICATION UNRESTRICTED	

Table of Contents

1	SCOPE	3
2	APPLICABLE STANDARDS	3
3	CATALOG NO. STRUCTURE	3
4	CONNECTOR SHAPE, DIMENSIONS AND MARTHRIALS	3
5	ACCOMMODATED CONDUCTORS (FPC/FFC)	3
6	PACKAGING CONDITION	3
7	RECOMMENDED MOUNTING PATTERN DIMENSIONS	3
8	RATING	4
8-1	Voltage	4
8-2	Current	4
8-3	Operating Temperature	4
9	PERFORMANCE CHARACTERISTICS	4
9-1	Electrical Performance	4
9-1-1	Contact resistance	4
9-1-2	Insulation resistance	5
9-1-3	Dielectric withstanding voltage	5
9-2	Mechanical Performance	5
9-2-1	Durability (Slider operation)	5
9-2-2	Vibration (Sinusoidal)	5

NUMBER GS-12-0844	TYPE PRODUCT SPECIFICATION		
TITLE 0.5mm Pitch FPC Connector SFV__R-3/4STE_HLF		PAGE 2 of 10	REVISION A
		AUTHORIZED BY Sei Watanabe	DATE 2011-2-9
		CLASSIFICATION UNRESTRICTED	

9-3	Environmental Performance	6
9-3-1	Damp heat (Steady state)	6
9-3-2	Salt spray	6
9-3-3	Change of temperature	7
9-4	Other performance	7
9-4-1	Soldering (Resistance to reflow soldering)	7
9-4-2	Soldering (Solderability) (Reflow)	8
9-4-3	Conductor retention force (Reference)	8
10	INDICATION AND PACKAGING	9
10-1	Indication	9
10-2	Packaging	9
11	REMARKS	9
12	RECOMMENDED REFLOW PROFILE	9
13	REVISION RECORD	10

NUMBER GS-12-0844	TYPE PRODUCT SPECIFICATION		
TITLE 0.5mm Pitch FPC Connector SFV__R-3/4STE_HLF		PAGE 3 of 10	REVISION A
		AUTHORIZED BY Sei Watanabe	DATE 2011-2-9
		CLASSIFICATION UNRESTRICTED	

1. SCOPE

This specification covers the requirements for the connector (SFV__R-3/4ST_E_HLF) with 0.5mm spacing to which the edge of FPC(Flexible Printed Circuit) can be connected by Zero-Insertion-Force method and with cable lock mechanism and which copes with automatic mounting and SMT.

2. APPLICABLE STANDARDS

JIS C 5402 Method for Test of Connectors for Electronic Equipment

JIS C 0806 Packing of Electronic Components on Continuous Tapes
(Surface Mount Components)

UL – 94 TESTS FOR FLAMMABILITY OF PLASTIC MATERIALS FOR PARTS IN DEVICES AND APPLIANCES.

3. CATALOG No. STRUCTURE

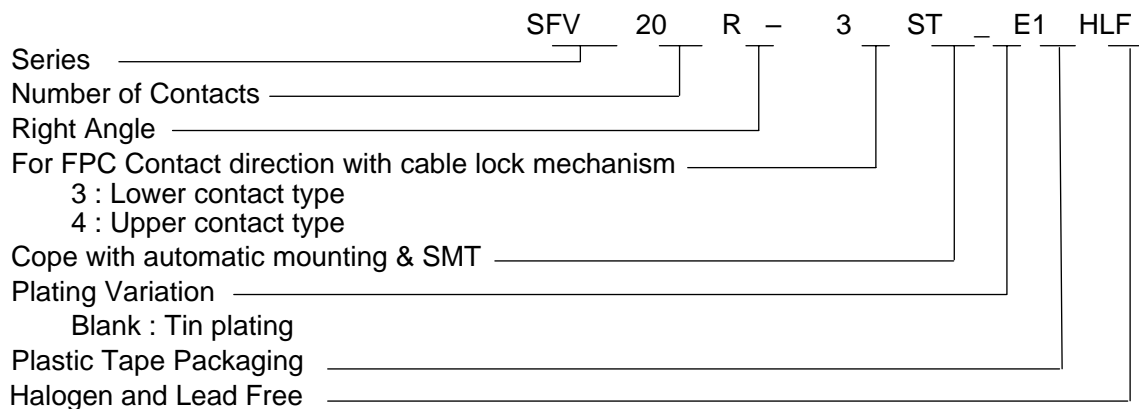

4. CONNECTOR SHAPE, DIMENSIONS AND MATERIALS

See attached drawings.

5. ACCOMMODATED CONDUCTORS (FPC/FFC)

See attached drawings.

6. PACKAGING CONDITION

See attached drawings.

7. RECOMMENDED MOUNTING PATTERN DIMENSIONS

See attached drawings.

NUMBER GS-12-0844	TYPE PRODUCT SPECIFICATION		
TITLE 0.5mm Pitch FPC Connector SFV__R-3/4STE_HLF		PAGE 4 of 10	REVISION A
		AUTHORIZED BY Sei Watanabe	DATE 2011-2-9
		CLASSIFICATION UNRESTRICTED	

8. RATING

8-1. Voltage : A.C.50V D.C.50V

8-2. Current : A.C.0.5A D.C.0.5A (Refer to the following note.)

8-3. Operating Temperature : -55°C ~ +105°C (Including terminal temperature rises)

NOTE

Allowable maximum current for one contact is 0.5A. Total allowable current for a whole connector is the value which is shown in the following figure.

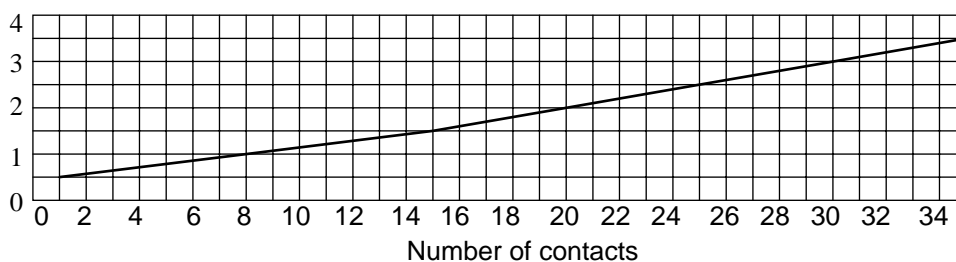

9. PERFORMANCE CHARACTERISTICS

9-1. Electrical Performance

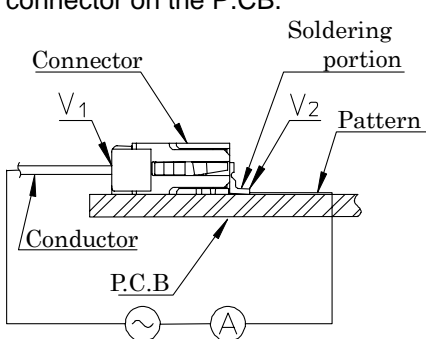
No.	Test Item	Test Method	Requirements
9-1-1	Contact resistance	<p>1) Measure contact resistance between V_1-V_2 by voltage drop method by the following circuit by mating accommodated conductor specified in clause 5 after reflow soldering the connector on the P.C.B.</p>  <p>2) Open circuit voltage : Less than A.C.20mV 3) Test current : Less than A.C.20mA</p>	<p>1) Initial value : Less than 30mΩ 2) Contact resistance after the test is in accordance with the value specified in each test item.</p>

NUMBER GS-12-0844	TYPE PRODUCT SPECIFICATION		
TITLE 0.5mm Pitch FPC Connector SFV__R-3/4STE_HLF		PAGE 5 of 10	REVISION A
		AUTHORIZED BY Sei Watanabe	DATE 2011-2-9
CLASSIFICATION UNRESTRICTED			

9-1-2	Insulation resistance	1)Measure insulation resistance between adjacent contacts in a connector individual. 2)Test voltage : D.C.500V 3)Read value one minute after applying test voltage.	1)More than 100M Ω
9-1-3	Dielectric withstanding voltage	1)For one minute, apply A.C.200V between adjacent contacts in a connector individual. 2)Set current : A.C.1mA	1)Free from any short circuit and insulation breakdown.

9-2. Mechanical Performance

No.	Test Item	Test Method	Requirements
9-2-1	Durability (Slider operation)	1)Measure contact resistance before and after the test by the method in clause 9-1-1 by mating the accommodated conductor specified in clause 5. 2) Number of slider open and close : 20 times (Insert and extract the conductor for each opening of the slider.)	1)Initial contact resistance : Less than 30m Ω 2)Contact resistance after the test : Less than 50m Ω 3)Free from any defect such as break etc. on the connector and conductor.
9-2-2	Vibration (Sinusoidal)	JIS C 60068-2-6 (IEC60068-2-6) 1)Frequency range : 10 ~ 500Hz 2)Amplitude : 0.75mm or Acceleration : 100m/s ² 3)Sweep rate : 1 octave/minute 4)Kind of test : Sweep endurance test 5)Test time : 10 cycles	1)During the test, no circuit opening for more than 1 μ s. 2)Free from any defect such as break, deformation, loosening and falling off etc. on each portion of the connector.

NUMBER GS-12-0844	TYPE PRODUCT SPECIFICATION		
TITLE 0.5mm Pitch FPC Connector SFV__R-3/4STE_HLF		PAGE 6 of 10	REVISION A
		AUTHORIZED BY Sei Watanabe	DATE 2011-2-9
CLASSIFICATION UNRESTRICTED			

9-3. Environmental Performance

No.	Test Item	Test Method	Requirements
9-3-1	Damp heat (Steady state)	<p>JIS C 60068-2-78 (IEC60068-2-78)</p> <p>1) Measure contact resistance before and after the test by the method in clause 9-1-1 by using the accommodated conductor specified in clause 5.</p> <p>2) Measure insulation resistance after the test by the method in clause 9-1-2.</p> <p>3) Bath temperature : 40°C</p> <p>4) Bath humidity : 90 ~ 95%(relative humidity)</p> <p>5) Period of exposure : 48 hours</p> <p>6) Expose conductor and connector in mated condition and leave them under normal temperature.(Without insertion and separation)</p>	<p>1) Initial contact resistance : Less than 30mΩ</p> <p>2) Contact resistance after the test : Less than 50mΩ</p> <p>3) Insulation resistance after the test : More than 100MΩ</p>
9-3-2	Salt spray	<p>JIS C 60068-2-11 (IEC60068-2-11)</p> <p>1) Measure contact resistance before and after the test according to the method in clause 9-1-1 by using accommodated conductor specified in clause 5.</p> <p>2) Salt solution concentration : 5%</p> <p>3) Period of exposure : 48 hours</p> <p>4) Expose conductor and connector in mated condition and leave them under normal temperature after posttreatment. (24 hours)</p>	<p>1) Initial contact resistance : Less than 30mΩ</p> <p>2) Contact resistance after the test : Less than 50mΩ</p>

NUMBER GS-12-0844	TYPE PRODUCT SPECIFICATION		
TITLE 0.5mm Pitch FPC Connector SFV__R-3/4STE_HLF		PAGE 7 of 10	REVISION A
		AUTHORIZED BY Sei Watanabe	DATE 2011-2-9
CLASSIFICATION UNRESTRICTED			

9-3-3	Change of temperature	<p>JIS C 0025 (IEC60068-2-14)</p> <p>1) Measure contact resistance before and after the test according to the method in clause 9-1-1 by using accommodated conductor specified in clause 5.</p> <p>2) One cycle of temperature is as follow and test 5 cycles.</p> <table border="1" style="margin-left: auto; margin-right: auto;"> <thead> <tr> <th>Step</th> <th>Temp.(°C)</th> <th>Time(min.)</th> </tr> </thead> <tbody> <tr> <td>1</td> <td>-55±3</td> <td>30</td> </tr> <tr> <td>2</td> <td>25±2</td> <td>2 ~ 3</td> </tr> <tr> <td>3</td> <td>85±2</td> <td>30</td> </tr> <tr> <td>4</td> <td>25±2</td> <td>2 ~ 3</td> </tr> </tbody> </table> <p>3) Expose conductor and connector in mated condition and leave them under normal temperature.</p>	Step	Temp.(°C)	Time(min.)	1	-55±3	30	2	25±2	2 ~ 3	3	85±2	30	4	25±2	2 ~ 3	<p>1) Initial contact resistance : Less than 30mΩ</p> <p>2) Contact resistance after the test : Less than 50mΩ</p> <p>3) Free from any defect such as crack, warping and deformation etc. on each portion the connector.</p>
Step	Temp.(°C)	Time(min.)																
1	-55±3	30																
2	25±2	2 ~ 3																
3	85±2	30																
4	25±2	2 ~ 3																

9-4. Other performance

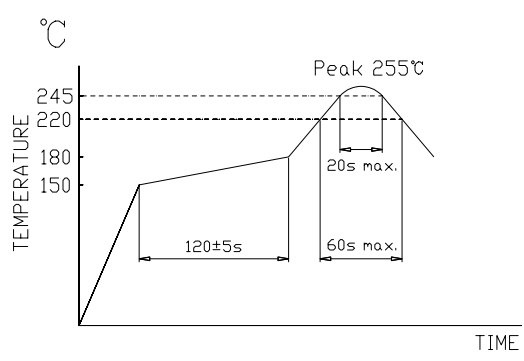
No.	Test Item	Test Method	Requirements
9-4-1	Soldering (Resistance to reflow soldering)	<p>JIS C 60068-2-58 (IEC60068-2-58)</p> <p>1) Solder by setting reflow bath on the following condition.</p> <p>2) Preheating : 150~180°C, 120±5 s</p> <p>3) Soldering : 220°C min. 60s max.</p> <p>4) Peak : 245°C min. 20s max. (Peak 255°C max.)</p> <p>NOTE : Temperature must be measured at contact terminal portion and peak temperature on the upper surface of P.C.B must be less than 260°C.</p> <p>5) Solder paste to be used is JIS Z 3282 Sn96.5Ag3.0Cu0.5</p> <p><u>Diagram A</u></p>	<p>1) Contact resistance after the test : Less than 50mΩ</p> <p>2) Insulation resistance after the test : More than 100MΩ</p> <p>3) No short circuit and insulation breakdown for dielectric withstanding voltage test after this test.</p> <p>4) Free from any damage on performance and contact performance after soldering.</p>
		 <p style="text-align: center;">Resistance to reflow soldering profile.</p>	

PDS: Rev :A

STATUS:Released

Printed: Feb 18, 2011

NUMBER GS-12-0844	TYPE PRODUCT SPECIFICATION		
TITLE 0.5mm Pitch FPC Connector SFV__R-3/4STE_HLF		PAGE 8 of 10	REVISION A
		AUTHORIZED BY Sei Watanabe	DATE 2011-2-9
		CLASSIFICATION UNRESTRICTED	

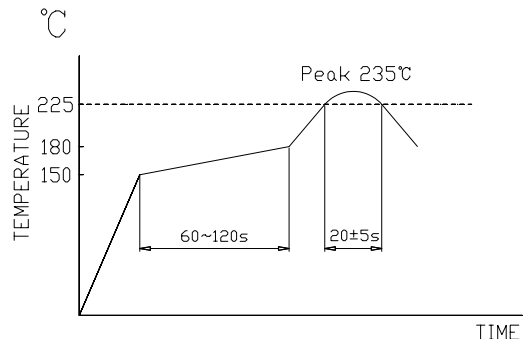
9-4-2	Soldering (Solderability) (Reflow)	<p>JIS C 60068-2-58 (IEC60068-2-58)</p> <p>1) Solder by setting reflow bath on the following condition.</p> <p>2) Preheating : 150~180°C, 60~120s</p> <p>3) Soldering : 225°C min., 20±5s (Peak 235°C max.)</p> <p>NOTE : Temperature must be measured at</p> <p style="padding-left: 40px;">contact terminal portion and peak temperature on the upper surface of P.C.B must be less than 260°C.</p> <p>4) Solder paste to be used is JIS Z 3282 Sn96.5Ag3.0Cu0.5</p>	1) Actual soldered area must be more than 90% of the dipped area intended to be soldered.
		<p><u>Diagram B</u></p>  <p style="text-align: center;">Solderability profile</p>	
9-4-3	Conductor retention force (Reference)	<p>1) Measure initial retention force after inserted and locked by using accommodated conductor specified in clause 5.</p> <p>*FCI Test FPC : t=0.33mm Tin plating</p>	1) More than 0.59N/contact (60gf/contact)

NUMBER GS-12-0844	TYPE PRODUCT SPECIFICATION		
TITLE 0.5mm Pitch FPC Connector SFV__R-3/4STE_HLF		PAGE 9 of 10	REVISION A
		AUTHORIZED BY Sei Watanabe	DATE 2011-2-9
		CLASSIFICATION UNRESTRICTED	

10. INDICATION AND PACKAGING

10-1. Indication

- 1) Catalog number and lot number are not be indicated on the connector.
- 2) Catalog number and quantity shall be indicated on the surface of the package box.

10-2. Packaging

- 1) The connector individuals are packed by tapes with specified quantity in accordance with [JIS C 0806 "Packaging of Electronic Components on Continuous Tapes (Surface Mount components)"] and put into package box in accordance with FCI JAPAN packaging specification.

11. REMARKS

- 11-1. Please refer to the "Handling procedures and remarks" before use.
- 11-2. Retention force for accommodated conductor specified in clause 9-4-3 differs due to different thickness, structure and surface treatment of conductor. Therefore, the value of retention force specified in the clause for performance is reference value.
- 11-3. Since this connector can not be used for CIC (Conductor such as silver paste, carbon etc.) as accommodated conductor, please consult us separately.

12. RECOMMENDED REFLOW PROFILE

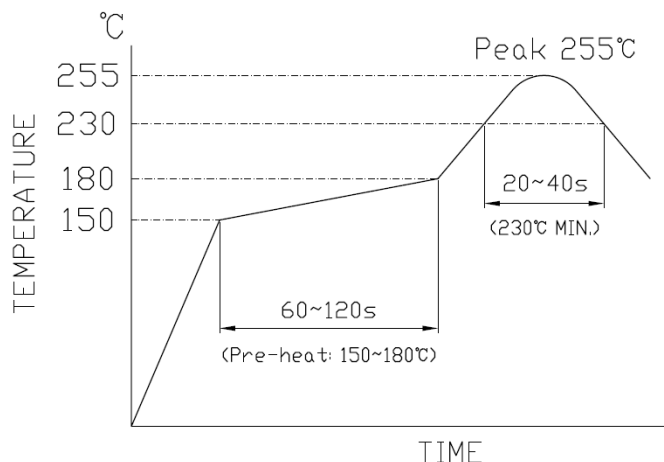



Diagram C. Recommended reflow temperature profile

Note: Please check the reflow soldering condition for your own application beforehand due to different conditions with soldering devices, P.C. Boards, etc.
No moisture treatment before reflow process.

NUMBER GS-12-0844	TYPE PRODUCT SPECIFICATION		
TITLE 0.5mm Pitch FPC Connector SFV__R-3/4STE_HLF		PAGE 10 of 10	REVISION A
		AUTHORIZED BY Sei Watanabe	DATE 2011-2-9
		CLASSIFICATION UNRESTRICTED	

REVISION RECORD

<u>Rev</u>	<u>Page</u>	<u>Description</u>	<u>EC#</u>	<u>Date</u>
A	All	New Release		2011/02/9