



| | | | |
|--|------------------------------|---|-----------|
| NUMBER | TYPE |  | |
| SC-SFW 14 | PRODUCT SPECIFICATION | | |
| TITLE FPC/FFC CONNECTOR (SFW_R-1/2STAE_LF/SFW_R-1/2STGE_LF/SFW_R-1/2STGHE_LF) | | PAGE | REVISION |
| | | 1 of 11 | G |
| | | AUTHORIZED BY | DATE |
| | | M.YAMASHITA | 24 Nov 09 |
| | | CLASSIFICATION | |
| | | UNRESTRICTED | |

Table of Contents:

| | | |
|---|---|---|
| 1 | SCOPE | 3 |
| 2 | APPLICABLE STANDARDS | 3 |
| 3 | CATALOG NO. STRUCTURE | 3 |
| 4 | CONNECTOR SHAPE, DIMENSIONS AND MATERIALS | 3 |
| 5 | ACCOMMODATED CONDUCTORS (FPC) | 3 |
| 6 | PACKAGING CONDITION | 3 |
| 7 | RECOMMENDED MOUNTING PATTERN DIMENSIONS | 3 |
| 8 | RATING | 4 |
| | 8-1 Voltage | 4 |
| | 8-2 Current | 4 |
| | 8-3 Operating Temperature | 4 |
| 9 | PERFORMANCE CHARACTERISTICS | 4 |
| | 9-1 Electrical Performance | 4 |
| | 9-1-1 Contact resistance | 4 |
| | 9-1-2 Insulation resistance | 5 |
| | 9-1-3 Dielectric withstanding voltage | 5 |
| | 9-2 Mechanical Performance | 5 |
| | 9-2-1 Durability (Slider operation) | 5 |
| | 9-2-2 Vibration (Sinusoidal) | 5 |

| | | | |
|---|--------------------------------------|---|-------------------|
| NUMBER SC-SFW 14 | TYPE PRODUCT SPECIFICATION |  | |
| TITLE FPC/FFC CONNECTOR (SFW_R-1/2STAE_LF/SFW_R-1/2STGE_LF/SFW_R-1/2STGHE_LF) | | PAGE 2 of 11 | REVISION G |
| | | AUTHORIZED BY M.YAMASHITA | DATE 24 Nov 09 |
| | | CLASSIFICATION UNRESTRICTED | |

| | | |
|-------|--|----|
| 9-3 | Environmental Performance | 6 |
| 9-3-1 | Damp heat (Steady state) | 6 |
| 9-3-2 | Salt spray | 6 |
| 9-3-3 | Change of temperature | 7 |
| 9-4 | Other performance | 8 |
| 9-4-1 | Soldering (Resistance to reflow soldering) | 8 |
| 9-4-2 | Soldering (Solderability) (Reflow) | 9 |
| 9-4-3 | Conductor retention force (Reference) | 9 |
| 10 | INDICATION AND PACKAGING | 10 |
| 10-1 | Indication | 10 |
| 10-2 | Packaging | 10 |
| 11 | REMARKS | 10 |
| 12 | RECOMMENDED REFLOW PROFILE | 10 |
| 13 | REVISION RECORD | 11 |

| | | | |
|---|--------------------------------------|---|-------------------|
| NUMBER SC-SFW 14 | TYPE PRODUCT SPECIFICATION |  | |
| TITLE FPC/FFC CONNECTOR (SFW_R-1/2STAE_LF/SFW_R-1/2STGE_LF/SFW_R-1/2STGHE_LF) | | PAGE 3 of 11 | REVISION G |
| | | AUTHORIZED BY M.YAMASHITA | DATE 24 Nov 09 |
| CLASSIFICATION UNRESTRICTED | | | |

1. SCOPE

This specification covers the requirements for the connector (SFW__R-1/2ST_E_LF) with 1mm spacing to which the edge of FPC(Flexible Printed Circuit) can be connected by Zero-Insertion-Force method and which copes with automatic mounting and SMT.

2. APPLICABLE STANDARDS

- JIS C 5402 Method for Test of Connectors for Electronic Equipment
- JIS C 0806 Packaging of Electronic Components on Continuous Tapes
(Surface Mount Components)
- UL - 94 TESTS FOR FLAMMABILITY OF PLASTIC MATERIALS FOR PARTS
IN DEVICES AND APPLIANCES

3. CATALOG NO. STRUCTURE

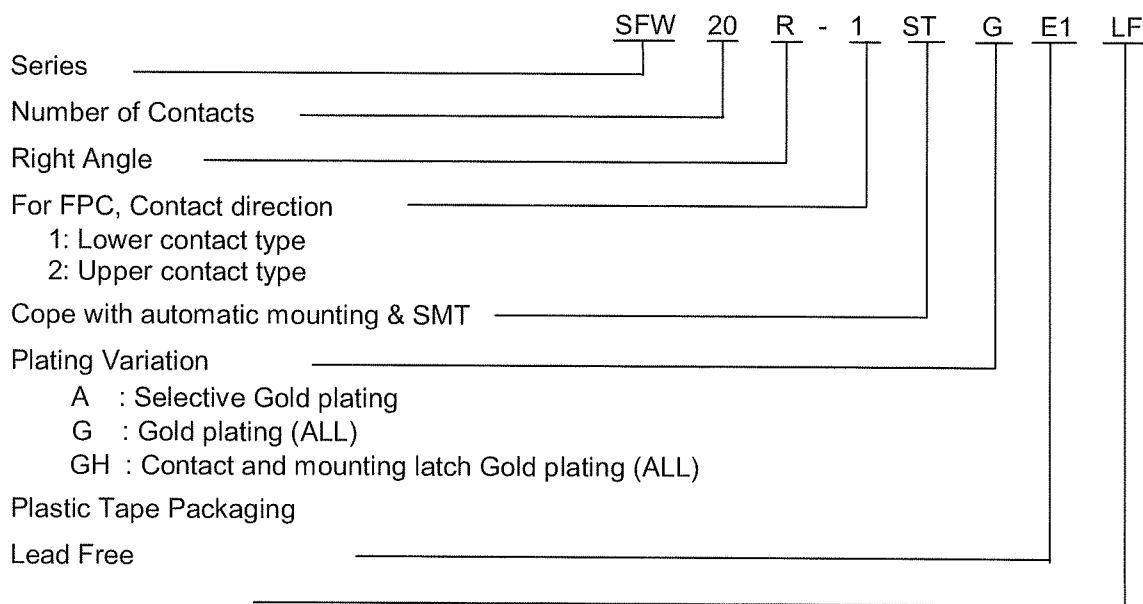

4. CONNECTOR SHAPE, DIMENSIONS AND MATERIALS

Refer product drawings.

5. ACCOMMODATED CONDUCTORS (FPC)

Refer product drawings.

6. PACKAGING CONDITION

Refer product drawings.

7. RECOMMENDED MOUNTING PATTERN DIMENSIONS

Refer product drawings.

| | | | |
|---|--------------------------------------|---|-------------------|
| NUMBER SC-SFW 14 | TYPE PRODUCT SPECIFICATION |  | |
| TITLE FPC/FFC CONNECTOR (SFW_R-1/2STAE_LF/SFW_R-1/2STGE_LF/SFW_R-1/2STGHE_LF) | | PAGE 4 of 11 | REVISION G |
| | | AUTHORIZED BY M.YAMASHITA | DATE 24 Nov 09 |
| CLASSIFICATION UNRESTRICTED | | | |

8. RATING

- 8-1. Voltage : A.C. 100V D.C. 100V
- 8-2. Current : A.C. 1A D.C. 1A (Refer to the following note.)
- 8-3. Operating Temperature : -55°C ~ +105°C (Including terminal temperature rise)

NOTE

Allowable maximum current for one contact is 1A. Total allowable current for a whole connector is the value which is shown in the following figure.

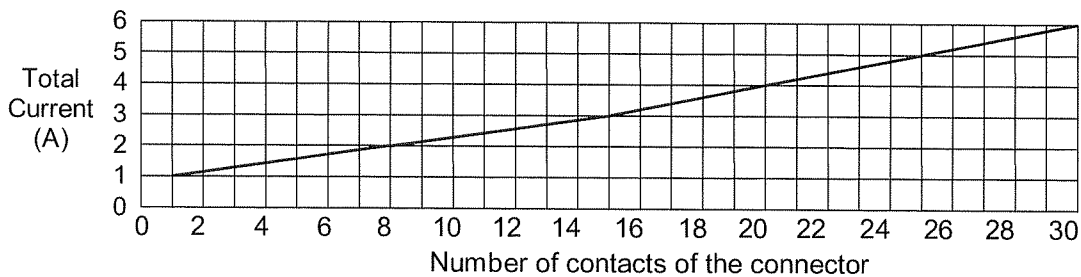

9. PERFORMANCE CHARACTERISTICS

9-1. Electrical Performance

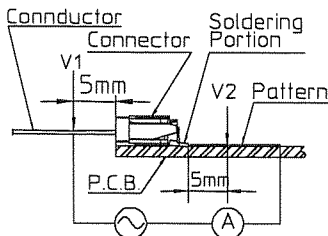
| No. | Test Item | Test Method | Requirements |
|-------|--------------------|--|--|
| 9-1-1 | Contact resistance | 1) Measure contact resistance between V_1 - V_2 by voltage drop method by the following circuit by mating accommodated conductor stipulated in clause 5 after reflow soldering the connector on the P.C.B. and cleaning flux dregs.  2) Open circuit voltage : Less than A.C. 20mV 3) Test current : Less than A.C. 20mA | 1) Initial value : Less than 30mΩ 2) Contact resistance after the test is in accordance with the value specified in each test item. |

| | | | |
|---|--------------------------------------|---|-------------------|
| NUMBER SC-SFW 14 | TYPE PRODUCT SPECIFICATION |  | |
| TITLE FPC/FFC CONNECTOR (SFW_R-1/2STAE_LF/SFW_R-1/2STGE_LF/SFW_R-1/2STGHE_LF) | | PAGE 5 of 11 | REVISION G |
| | | AUTHORIZED BY M.YAMASHITA | DATE 24 Nov 09 |
| CLASSIFICATION UNRESTRICTED | | | |

| No. | Test Item | Test Method | Requirements |
|-------|---------------------------------|---|--|
| 9-1-2 | Insulation resistance | 1) Measure insulation resistance between adjacent contacts in a connector individual. 2) Test voltage : D.C. 500V 3) Read value one minute after applying test voltage. | 1) More than 500MΩ |
| 9-1-3 | Dielectric withstanding voltage | 1) For one minute, apply A.C. 500V between adjacent contacts in a connector individual. 2) Set current : A.C. 1mA | 1) Free from any short circuit and insulation breakdown. |

9-2. Mechanical Performance

| No. | Test Item | Test Method | Requirements |
|-------|-------------------------------|---|---|
| 9-2-1 | Durability (Slider operation) | 1) Measure contact resistance before and after the test by the method in clause 9-1-1 by mating the accommodated conductor specified in clause 5. 2) Number of slider open and close : 20 times (Insert and extract the conductor for each opening of the slider.) | 1) Initial contact resistance : Less than 30mΩ 2) Contact resistance after the test : Less than 50mΩ 3) Free from any defect such as break etc. on the connector and the conductor. |
| 9-2-2 | Vibration (Sinusoidal) | JIS C 60068-2-6 (IEC60068-2-6) 1) Frequency range : 10 ~ 500Hz 2) Amplitude : 0.75mm or Acceleration : 100m/s ² 3) Sweep rate : 1 octave / minute 4) Kind of test : Sweep endurance test 5) Test time : 10 cycles | 1) During the test, no circuit opening for more than 1μs 2) Free from any defect such as break, deformation, loosening and falling off etc. on each portion of the connector. |

| | | | |
|---|--------------------------------------|---|-------------------|
| NUMBER SC-SFW 14 | TYPE PRODUCT SPECIFICATION |  | |
| TITLE FPC/FFC CONNECTOR (SFW_R-1/2STAE_LF/SFW_R-1/2STGE_LF/SFW_R-1/2STGHE_LF) | | PAGE 6 of 11 | REVISION G |
| | | AUTHORIZED BY M.YAMASHITA | DATE 24 Nov 09 |
| CLASSIFICATION UNRESTRICTED | | | |

9-3. Environmental Performance

| No. | Test Item | Test Method | Requirements |
|-------|-----------------------------|--|--|
| 9-3-1 | Damp heat (Steady state) | <p>JIS C 60068-2-78 (IEC60068-2-78)</p> <ol style="list-style-type: none"> 1) Measure contact resistance before and after the test by the method in clause 9-1-1 by using the accommodated conductor specified in clause 5. 2) Measure insulation resistance after the test by the method in clause 9-1-2. 3) Bath temperature : 40°C 4) Bath humidity: 90~95% (Relative humidity) 5) Period of exposure : 48 hours 6) Expose conductor and connector in mated condition and leave them under normal temperature. (Without insertion and separation) | <ol style="list-style-type: none"> 1) Initial contact resistance : Less than 30mΩ 2) Contact resistance after the test : Less than 50mΩ 3) Insulation resistance after the test : More than 100MΩ |
| 9-3-2 | Salt spray | <p>JIS C 60068-2-11 (IEC60068-2-11)</p> <ol style="list-style-type: none"> 1) Measure contact resistance before and after the test according to the method in clause 9-1-1 by using accommodated conductor specified in clause 5. 2) Salt solution concentration : 5% 3) Period of exposure : 48 hours 4) Expose conductor and connector in mated condition and leave them under normal temperature after post treatment. | <ol style="list-style-type: none"> 1) Initial contact resistance : Less than 30mΩ 2) Contact resistance after the test : Less than 50mΩ |

| | | | |
|---|--------------------------------------|---|-------------------|
| NUMBER SC-SFW 14 | TYPE PRODUCT SPECIFICATION |  | |
| TITLE FPC/FFC CONNECTOR (SFW_R-1/2STAE_LF/SFW_R-1/2STGE_LF/SFW_R-1/2STGHE_LF) | | PAGE 7 of 11 | REVISION G |
| | | AUTHORIZED BY M.YAMASHITA | DATE 24 Nov 09 |
| CLASSIFICATION UNRESTRICTED | | | |

| No. | Test Item | Test Method | Requirements | | | | | | | | | | | | | | | |
|-------|-----------------------|---|--------------|-----------|-------------|---|-------|----|---|------|-------|---|------|----|---|------|-------|---|
| 9-3-3 | Change of temperature | <p>JIS C 0025 (IEC60068-2-14)</p> <p>1) Measure contact resistance before and after the test according to the method in clause 9-1-1 by using accommodated conductor in clause 5.</p> <p>2) One cycle of temperature is as follow and test 5 cycles.</p> <table border="1"> <thead> <tr> <th>Step</th> <th>Temp.(°C)</th> <th>Time (min.)</th> </tr> </thead> <tbody> <tr> <td>1</td> <td>-55±3</td> <td>30</td> </tr> <tr> <td>2</td> <td>25±2</td> <td>2 ~ 3</td> </tr> <tr> <td>3</td> <td>85±2</td> <td>30</td> </tr> <tr> <td>4</td> <td>25±2</td> <td>2 ~ 3</td> </tr> </tbody> </table> <p>3) Expose conductor and connector in mated condition and leave them under normal temperature.</p> | Step | Temp.(°C) | Time (min.) | 1 | -55±3 | 30 | 2 | 25±2 | 2 ~ 3 | 3 | 85±2 | 30 | 4 | 25±2 | 2 ~ 3 | <p>1) Initial contact resistance : Less than 30mΩ</p> <p>2) Contact resistance after the test : Less than 50mΩ</p> <p>3) Free from any defect such as crack, warping and deformation etc. on each portion of the connector.</p> |
| Step | Temp.(°C) | Time (min.) | | | | | | | | | | | | | | | | |
| 1 | -55±3 | 30 | | | | | | | | | | | | | | | | |
| 2 | 25±2 | 2 ~ 3 | | | | | | | | | | | | | | | | |
| 3 | 85±2 | 30 | | | | | | | | | | | | | | | | |
| 4 | 25±2 | 2 ~ 3 | | | | | | | | | | | | | | | | |

| | | | |
|---|--------------------------------------|---|-------------------|
| NUMBER SC-SFW 14 | TYPE PRODUCT SPECIFICATION |  | |
| TITLE FPC/FFC CONNECTOR (SFW_R-1/2STAE_LF/SFW_R-1/2STGE_LF/SFW_R-1/2STGHE_LF) | | PAGE 8 of 11 | REVISION G |
| | | AUTHORIZED BY M.YAMASHITA | DATE 24 Nov 09 |
| CLASSIFICATION UNRESTRICTED | | | |

9-4. Other performance

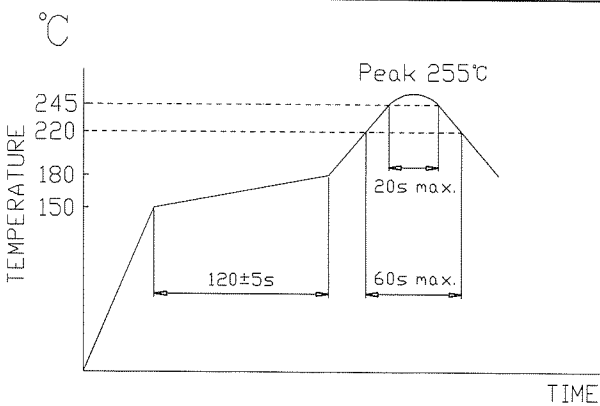
| No. | Test Item | Test Method | Requirements |
|--|---|--|--|
| 9-4-1 | Soldering (Resistance to reflow soldering) | <p>JIS C 60068-2-58 (IEC60068-2-58)</p> <p>1) Solder by setting reflow bath on the following condition.</p> <p>2) Preheating : 150~180°C, 120±5s</p> <p>3) Soldering : 220°C min. 60s max.</p> <p>4) Peak : 245°C min. 20s max. (Peak 255°C max.) (See Diagram A)</p> <p>Note: Temperature must be measured at contact terminal portion and peak temperature on the upper surface of P.C.B must be less than 260°C.</p> <p>5) Solder paste to be used is JIS Z 3282 Sn96.5Ag3.0Cu0.5</p> | <p>1) Contact resistance after the test : Less than 50mΩ</p> <p>2) Insulation resistance after the test : More than 100MΩ</p> <p>3) No short circuit and insulation Breakdown for dielectric withstanding voltage test after this test.</p> <p>4) Free from any damage on performance and contact performance after soldering.</p> |
| <p><u>Diagram A</u></p>  <p>Resistance to reflow soldering profile</p> | | | |

| | | | |
|---|--------------------------------------|---|-------------------|
| NUMBER SC-SFW 14 | TYPE PRODUCT SPECIFICATION |  | |
| TITLE FPC/FFC CONNECTOR (SFW_R-1/2STAE_LF/SFW_R-1/2STGE_LF/SFW_R-1/2STGHE_LF) | | PAGE 9 of 11 | REVISION G |
| | | AUTHORIZED BY M.YAMASHITA | DATE 24 Nov 09 |
| CLASSIFICATION UNRESTRICTED | | | |

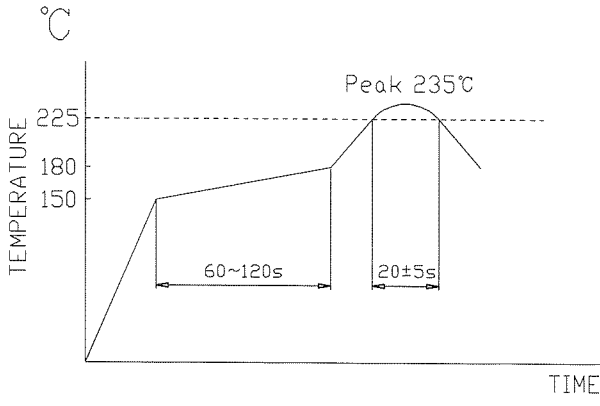
| No. | Test Item | Test Method | Requirements |
|-------|--|---|---|
| 9-4-2 | Soldering (Solderability) (Reflow) | <p>JIS C 60068-2-58 (IEC60068-2-58)</p> <p>1) Solder by setting reflow bath on the following condition.</p> <p>2) Preheating: 150~180°C, 60~120s</p> <p>3) Soldering : 225°C min., 20±5s (Peak 235°C max.) (See Diagram B)</p> <p>Note: Temperature must be measured at contact terminal portion and peak temperature on the upper surface of P.C.B must be less than 260°C.</p> <p>4) Solder paste to be used is JIS Z 3282 Sn96.5Ag3.0Cu0.5</p> | 1) Actual soldered area must be more than 95% of the dipped area intended to be soldered. |
| | | <p><u>Diagram B</u></p>  <p style="text-align: center;">Solderability profile</p> | |
| 9-4-3 | Conductor retention force (Reference) | 1) Measure initial retention force after inserted and locked by using accommodated conductor specified in clause 5. | 1) More than 0.49N/contact for FPC (More than 50gf/contact for FPC) |

| | | | |
|---|--------------------------------------|---------------------------------------|-------------------|
| NUMBER SC-SFW 14 | TYPE PRODUCT SPECIFICATION | FCI | |
| TITLE FPC/FFC CONNECTOR (SFW_R-1/2STAE_LF/SFW_R-1/2STGE_LF/SFW_R-1/2STGHE_LF) | | PAGE 10 of 11 | REVISION G |
| | | AUTHORIZED BY M.YAMASHITA | DATE 24 Nov 09 |
| | | CLASSIFICATION UNRESTRICTED | |

10. INDICATION AND PACKAGING

10-1. Indication

- 1) Catalog number and lot number are not indicated on the connector.
- 2) Catalog number and quantity shall be indicated on the surface of the package box.

10-2. Packaging

- 1) The connector individuals are packed by tapes with specified quantity in accordance with [JIS C 0806 "Packaging of Electronic Components on Continuous Tapes (Surface Mount components)"] and put into package box in accordance with FCI packaging specification.

11. REMARKS

11-1. Please refer to the "Handling procedures and remarks" before use.

11-2. Retention force for accommodated conductor specified in clause 9-4-3 differs due to its kind, structure and surface treatment of conductor. Therefore, the value of retention force specified in the clause for performance is reference value.

11-3. Please use for Gold plating FPC as accommodated conductor.

12. RECOMMENDED REFLOW PROFILE

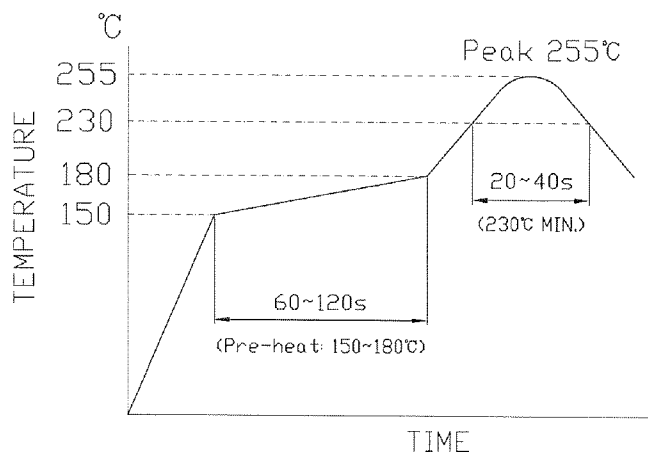



Diagram C. Recommended reflow temperature profile

Note: Please check the reflow soldering condition for your own application beforehand due to different conditions with soldering devices, P.C. Boards, etc.
No moisture treatment before reflow process.

| | | | |
|---|--------------------------------------|---|-------------------|
| NUMBER SC-SFW 14 | TYPE PRODUCT SPECIFICATION |  | |
| TITLE FPC/FFC CONNECTOR (SFW_R-1/2STAE_LF/SFW_R-1/2STGE_LF/SFW_R-1/2STGHE_LF) | | PAGE 11 of 11 | REVISION G |
| | | AUTHORIZED BY M.YAMASHITA | DATE 24 Nov 09 |
| | | CLASSIFICATION UNRESTRICTED | |

13. REVISION RECORD

| REV. | PAGE | DESCRIPTION | ECR # | DATE |
|------|----------|---|----------|-----------|
| | All | New release | J03-0421 | 14 Oct 03 |
| A | All | Add Cat. No. | J04-0437 | 03 Dec 04 |
| B | All | Spec update | J05-0055 | 07 Feb 05 |
| C | 5 | Correct solder operation to slider operation | J06-0080 | 01 Mar 06 |
| D | All 3 | Revise format of product spec. Operating Temperature change from -55°C ~ +85°C to -55°C ~ +105°C | S07-0192 | 21 Mar 07 |
| E | 3 – 6 | Revise spec for lead-free solder Add "Diagram A" Resistance to Reflow Soldering Profile. Add "Diagram B" Solderability Profile. | S09-0075 | 09 Mar 09 |
| F | All | Add Table of contents Add "Diagram C" Recommended Reflow Profile. | J09-0371 | 16 Oct 09 |
| G | 11 | Corrected paragraph Number. | J09-0410 | 24 Nov 09 |