

PRODUCT NUMBER
SEE PART NO. SCHEME

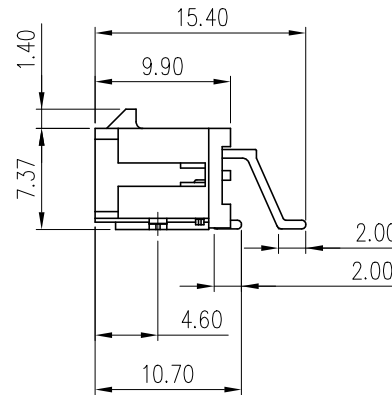
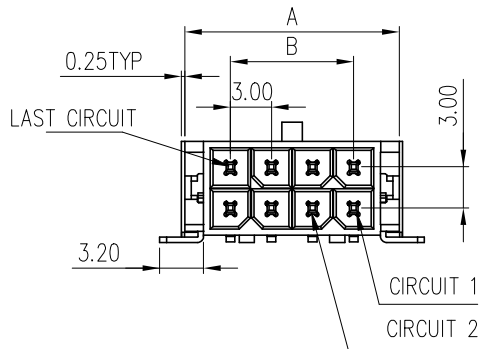
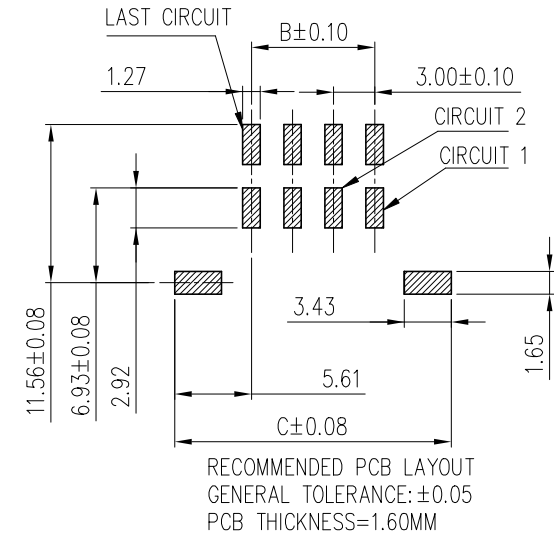
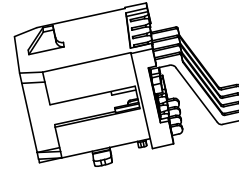
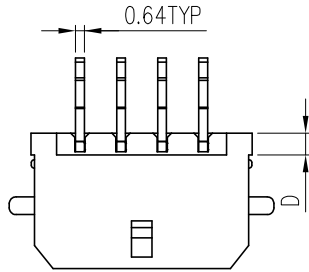

NOTES:

- MATERIALS:
HOUSING: OPTIONAL, UL94V-0, HALOGEN FREE, COLOR: BLACK
TERMINAL: COPPER ALLOY
HOLD DOWN: COPPER ALLOY
- FINISH:
TERMINAL: OPTIONAL
HOLD DOWN: MATTE TIN
UNDER PLATING: NICKEL OVERALL
- PRODUCT SPECIFICATION: GS-12-1177
- PACKAGE SPECIFICATION: GS-14-2359
- THIS PART MATES WITH FCI RECEPTACLE WIRE CONNECTOR 10127716.
- THIS PART IS APPLICABLE FOR REFLOW PROCESS WITH 260°C PEAK TEMPERATURE FOR 10 SECONDS.

DIMENSION TABLE

| POS | A | B | C | D |
|-----|-------|-------|-------|------|
| 02 | 6.65 | NA | 11.20 | 6.74 |
| 04 | 9.65 | 3.00 | 14.20 | |
| 06 | 12.65 | 6.00 | 17.20 | 1.60 |
| 08 | 15.65 | 9.00 | 20.20 | |
| 10 | 18.65 | 12.00 | 23.20 | |
| 12 | 21.65 | 15.00 | 26.20 | |
| 14 | 24.65 | 18.00 | 29.20 | |
| 16 | 27.65 | 21.00 | 32.20 | |
| 18 | 30.65 | 24.00 | 35.20 | |
| 20 | 33.65 | 27.00 | 38.20 | |
| 22 | 36.65 | 30.00 | 41.20 | |
| 24 | 39.65 | 33.00 | 44.20 | |

PART NUMBER SCHEME:
10137924-XX X X (X) LF

- NO OF POS. SPECIAL CHARACTER
02: 2 POS. Q: DEDICATED FOR CUSTOMER
 TAPE & REEL PACKAGING
24: 24 POS.
- HSG MATERIAL
1. LCP, GLOW WIRE COMPATIBLE
2. LCP, NON GLOW WIRE COMPATIBLE
- CONTACT PLATING
1. TIN
2. GOLD FLASH
3. 15u" Au, TIN ON SOLDER TAILS
4. 30u" Au, TIN ON SOLDER TAILS

| mat'l. code | | surface | tolerance | projection | product family |
|-------------|----------------|---------|------------|---------------------------------------|--|
| | | | ✓ | | MINITEK PWR3.0 |
| ltr | ecn no | dr | date | tolerances unless otherwise specified | title |
| A | | TAI | 2015-11-30 | angles X.X ±0.3 | MINITEK PWR3.0 R/A HEADER, DUAL ROW SMT TAILS AND HOLD DOWN |
| B | ELX-T-24982 | TAI | 2016-09-21 | lineal X.XX ±0.2 | |
| C | ELX-N-26477 | TONY | 2017-03-27 | X*±2° | |
| D | ELX-N-29860 | TONY | 2018-04-16 | dr | |
| | | enrg | KENNY TAI | 2015-11-26 | dwg no sheet 1 of 2 size 10137924 A4 |
| | | chr | KENNY TAI | 2015-11-26 | |
| | | appd | PM ZHENG | 2015-11-30 | |
| sheet index | revision sheet | D | D | type Product Customer Drawing | |
| | | 1 | 2 | | |

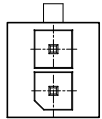

02 P

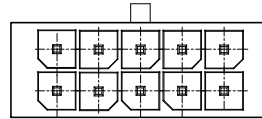

10 P

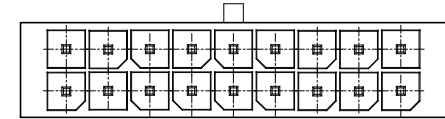

18 P

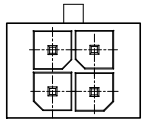

04 P

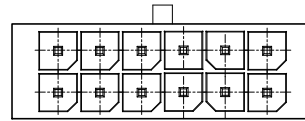

12 P

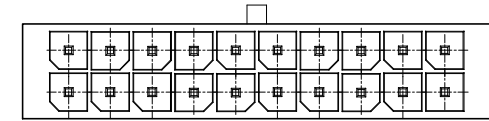

20 P

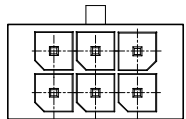

06 P

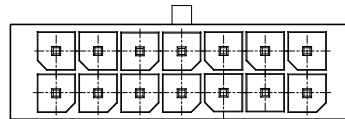

14 P

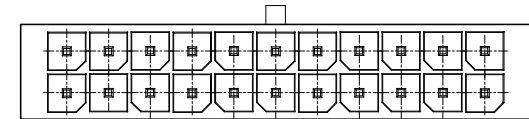

22 P

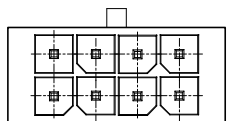

08 P

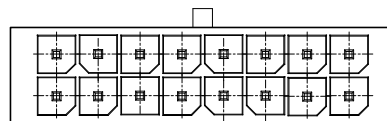

16 P

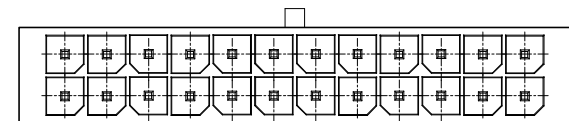

24 P

A

A

B

B

| | | | | | | | | | |
|-------------|----------------|---|-----------|---------------------------------------|--------|--------------|--|---|--|
| mat'l. code | | surface <input checked="" type="checkbox"/> | | tolerance | | projection | | product family MINITEK PWR3.0 | |
| ltr | ecn no | dr | date | tolerances unless otherwise specified | | mm | | title MINITEK PWR3.0 R/A HEADER, DUAL ROW SMT TAILS AND HOLD DOWN | |
| | | | | angles | linear | scale N.T.S. | | dwg no 10137924 | |
| | | | | X.X ±0.3 | | | | sheet 2 of 2 size A4 | |
| | | | | X.XX ±0.2 | | | | type Product Customer Drawing | |
| | | | | X'±2° | | | | | |
| | | dr | KENNY TAI | 2015-11-26 | | | | | |
| | | enr | KENNY TAI | 2015-11-26 | | | | | |
| | | chr | KENNY TAI | 2015-11-26 | | | | | |
| | | appd | PM ZHENG | 2015-11-30 | | | | | |
| sheet index | revision sheet | D | D | | | | | | |
| | 1 | 2 | | | | | | | |